

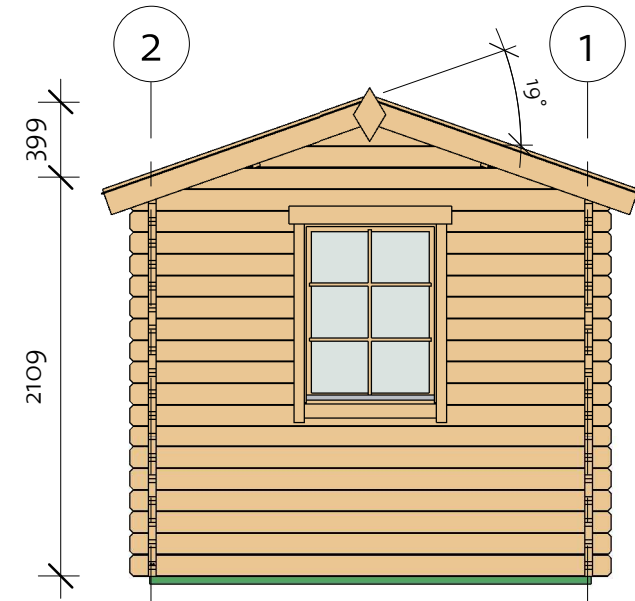

Karina 40 (415x235)

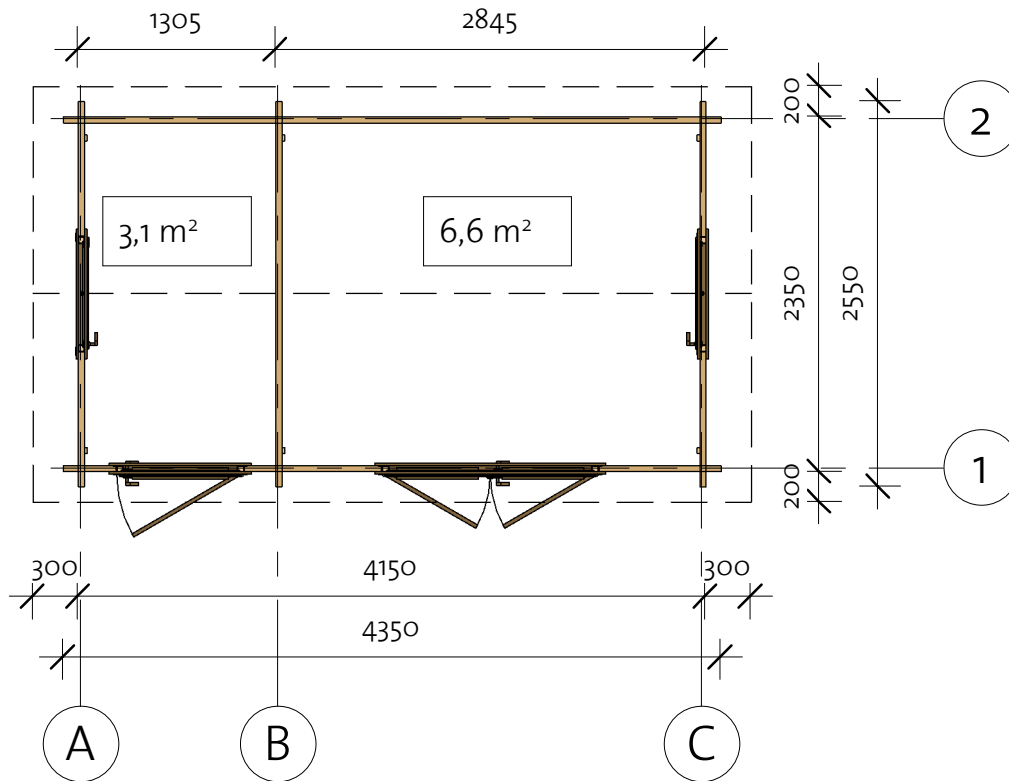

Karina 40 (415x235)

Foundation

Impregnated foundation beams				
Mark	Type	Profile	Count	Length
IFB1	IFB 70x40		5	4000
IFB2	IFB 70x40		2	2340

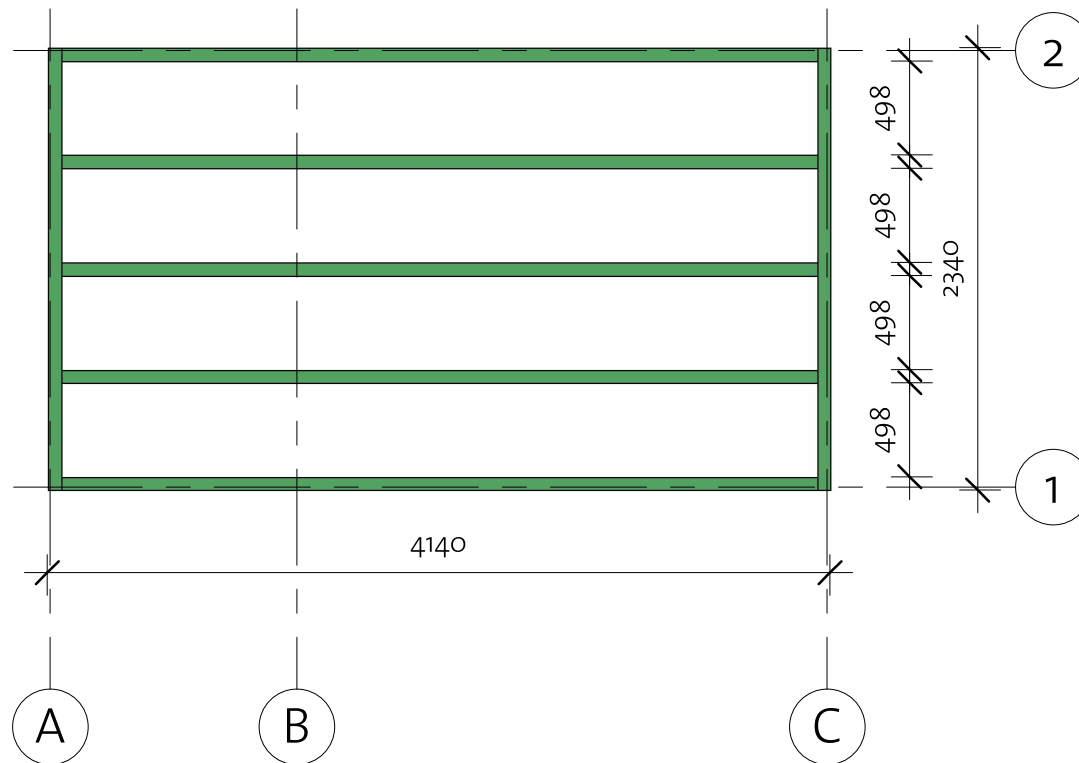



Karina 40 (415x235)

Floor Plan

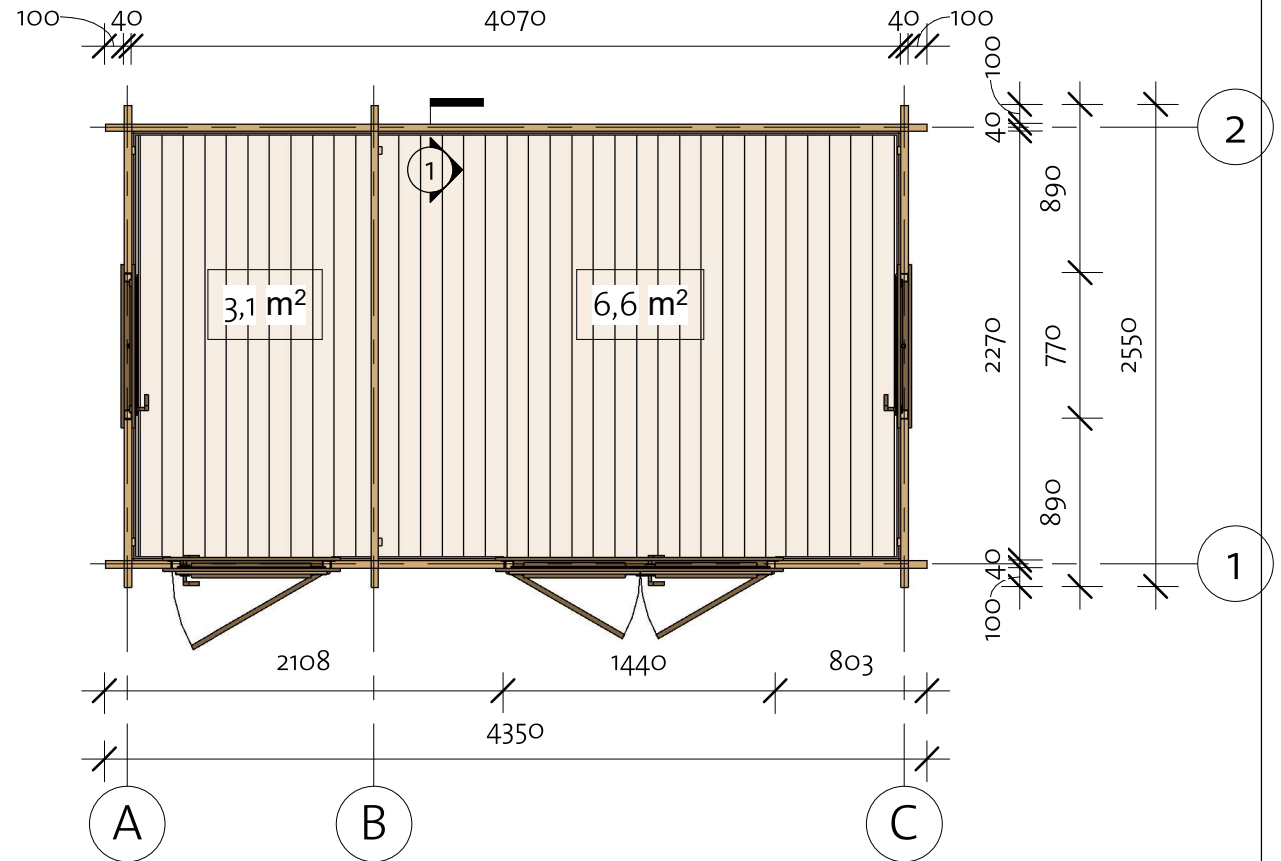
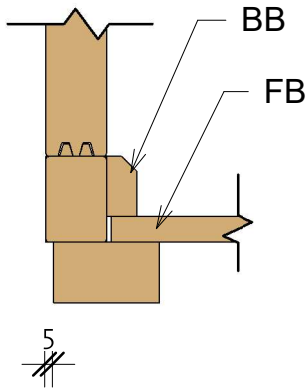
① Baseboard



Floor Schedule

Mark	Type	Profile	Count	Length
FB	FB 17x114		36	2264
BB1	BB 20x40		2	4100
BB2	BB 20x40		4	2300

92007291_200805

Karina 40 (415x235)

Wall 1

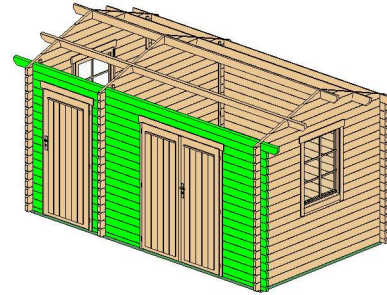

Wall 1			
Mark	Profile	Count	Cut Length

1BL-1	40x57	1	348
1BL-2	40x57	1	803
1BL-3	40x57	1	910
1LG-1	40x114	16	348
1LG-2	40x114	16	803
1LG-3	40x114	16	910
1LG-4	40x114	1	4350
1TL-1	40x114	1	4750

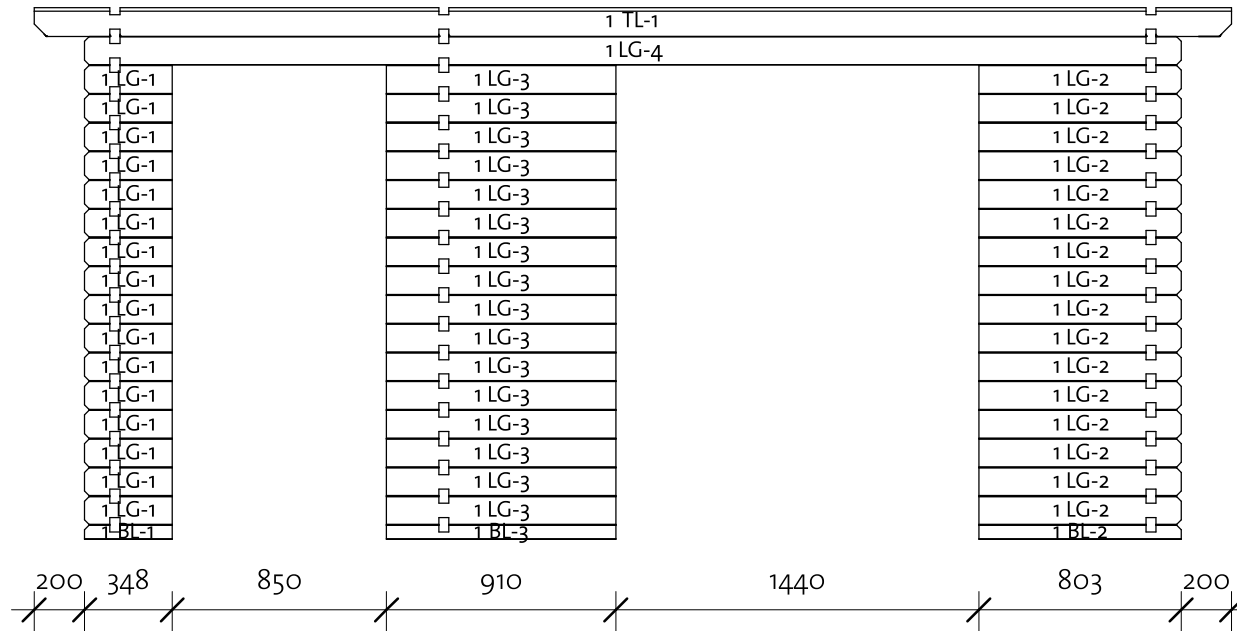

Log Profile Wall 1	
Profile	Profile

40x57	
40x114	
40x114	

Karina 40 (415x235)

Wall 2

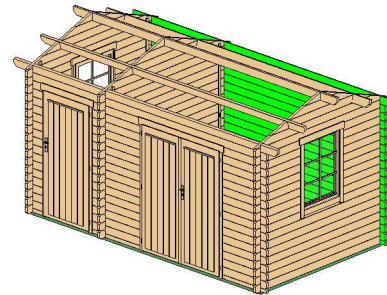

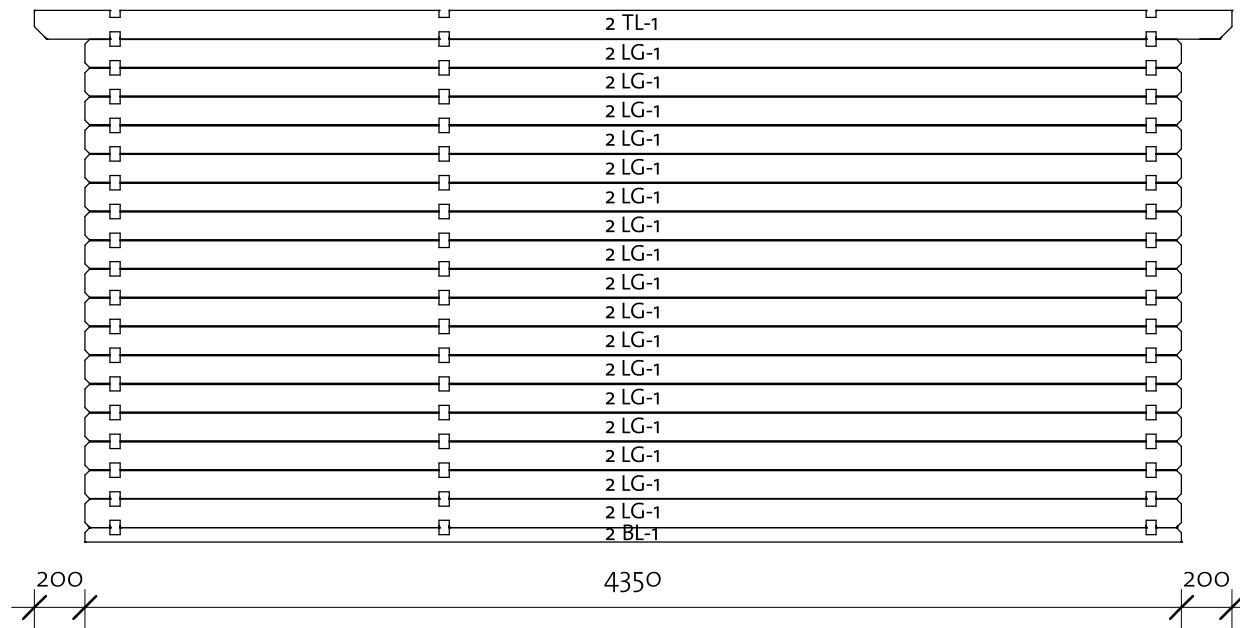

Wall 2			
Mark	Profile	Count	Cut Length

2BL-1	40x57	1	4350
2LG-1	40x114	17	4350
2TL-1	40x114	1	4750



Log Profile Wall 2	
Profile	Profile

40x57	
40x114	
40x114	

Karina 40 (415x235)

Wall A

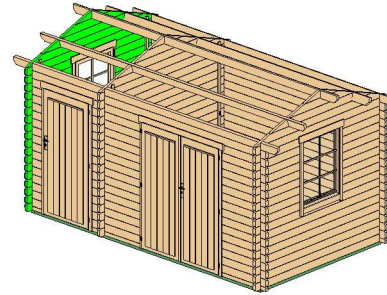

Wall A			
Mark	Profile	Count	Cut Length

ALG-1*	40x114	1	650
ALG-2*	40x114	1	1247
ALG-3*	40x114	1	1946
ALG-4*	40x114	1	2532
ALG-5	40x114	9	2550
ALG-6	40x114	18	890

* Gable delivered premounted

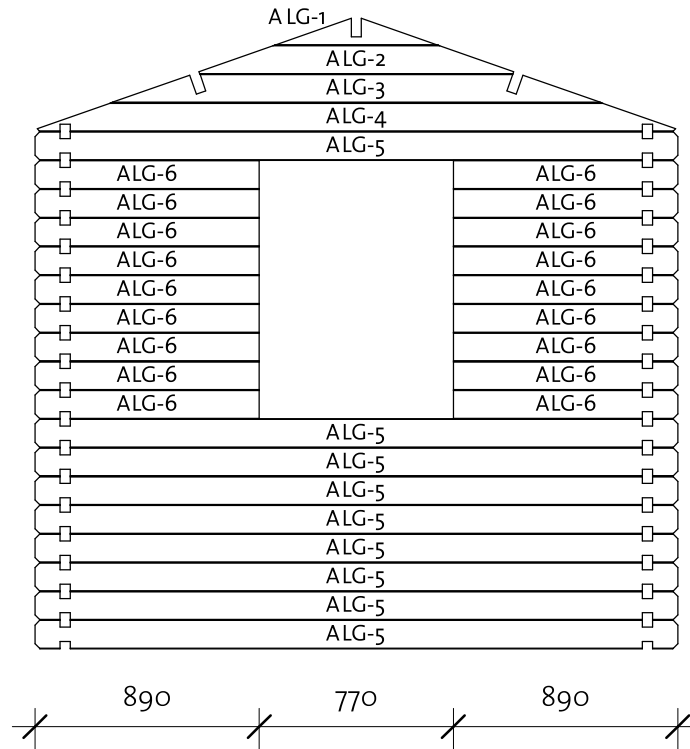

Log Profile Wall A	
Profile	Profile

40x114	
--------	---

Karina 40 (415x235)

Wall B

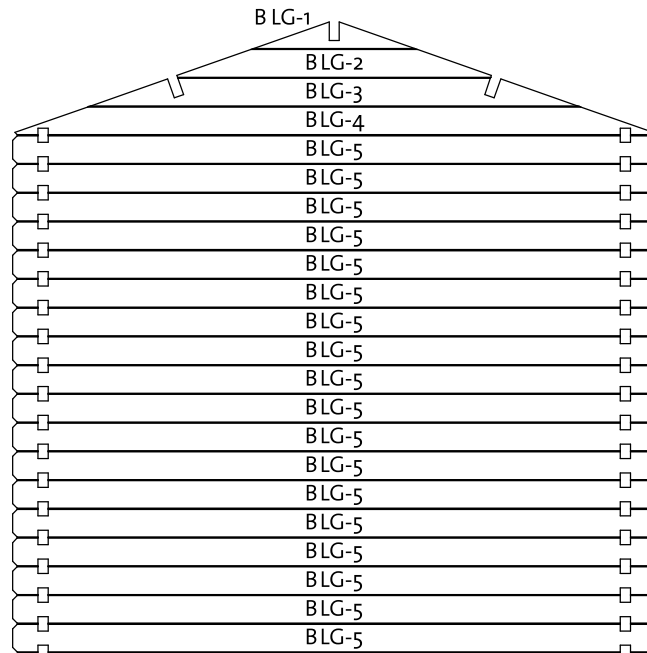
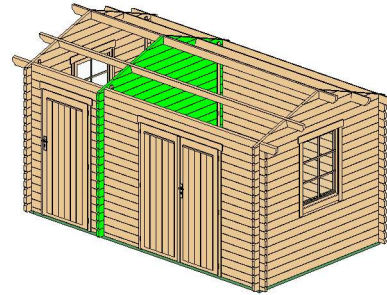

Wall B			
Mark	Profile	Count	Cut Length

BLG-1*	40x114	1	650
BLG-2*	40x114	1	1247
BLG-3*	40x114	1	1946
BLG-4*	40x114	1	2532
BLG-5	40x114	18	2550

* Gable delivered premounted

Log Profile Wall B

Profile

Profile

40x114

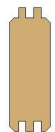

Karina 40 (415x235)

Wall C

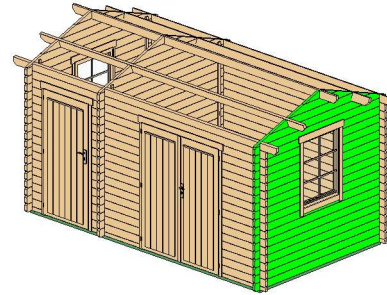

Wall C			
Mark	Profile	Count	Cut Length

CLG-1*	40X114	1	650
CLG-2*	40X114	1	1247
CLG-3*	40X114	1	1946
CLG-4*	40X114	1	2532
CLG-5	40X114	9	2550
CLG-6	40X114	18	890

* Gable delivered premounted

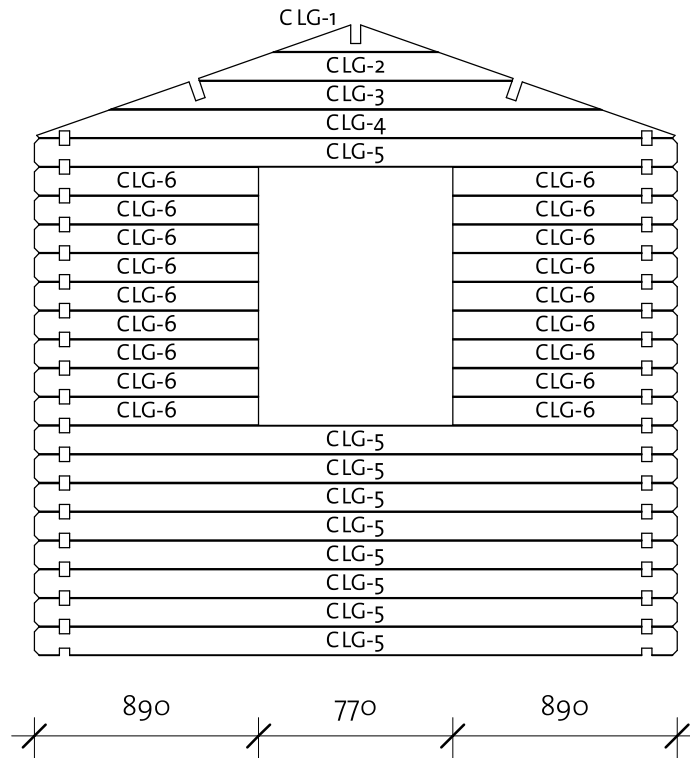





Log Profile Wall C	
Profile	Profile

40X114	
--------	--

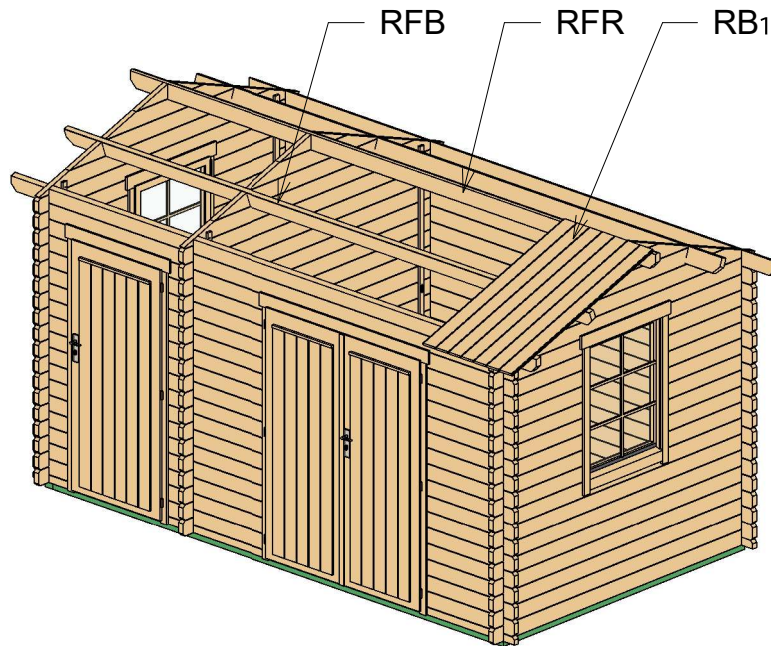
Karina 40 (415x235)

Roof 1



Roof				
Mark	Type	Profile	Count	Length
RFR	Ridge 40x120		1	4750
RFB	Beam 40x120		2	4750
RB	17x114		86	1452

Karina 40 (415x235)

Roof 2

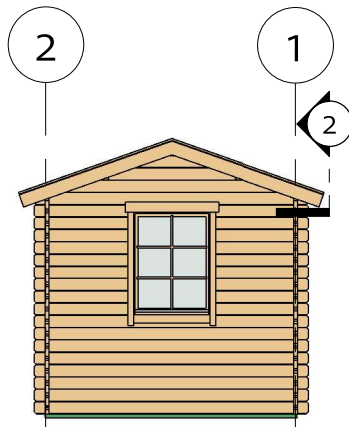

② Facia

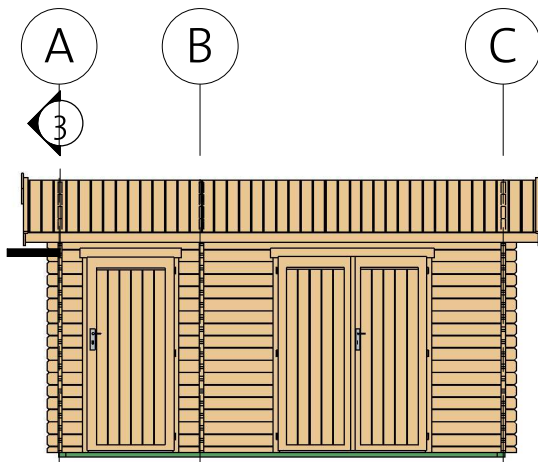
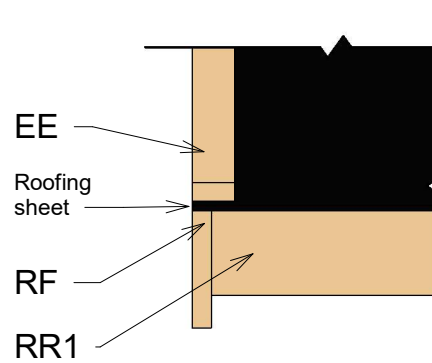

③ Roof Reinforcement

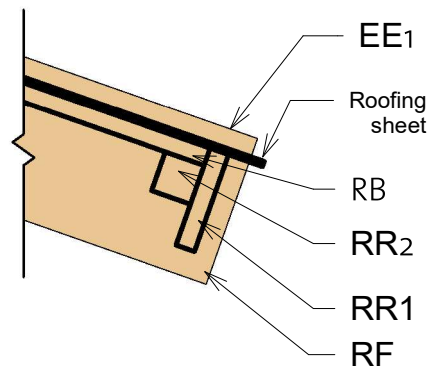

Fascia Schedule

Mark	Type	Profile	Count	Length
EE	Eave Edging 18x40		4	1496
RF	Roof Fascia 18x120		4	1496
RR1	Roof reinforce ment 18x95		2	4750
RR2	Roof reinforce ment 38x38		2	4750

Karina 40 (415x235)

Extras







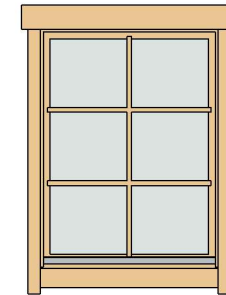

CDD26R	Classic double door 26, wood right	1425	1835	1
CD11R	Classic door 11, wood right	840	1835	1

CW1L	Classic window 1 left	765	990	1
CW1R	Classic window 1 right	765	990	1

WCB6	Windows Crossbar 6	--	--	2
------	--------------------	----	----	---



Hitblock	300-400 mm		
Screws	5,0 x 70		15
Bolts	M8x70		18
Screws	6,0 x 140		50
Nails	1,4 x 40		50
Screws	4,0 x 40		85
Screws	4,0 x 50		490

Type	Count
------	-------

Romb	2
------	---



Type	Count	Length
------	-------	--------

Windboard 18x40	6	2200
-----------------	---	------





Karina 40 (415X235)

List of all items 1

Impregnated foundation beams

Mark	Type	Profile	Count	Length
IFB1	IFB 70x40		5	4000
IFB2	IFB 70x40		2	2340

Roof





Mark	Type	Profile	Count	Length
RFR	Ridge 40x120		1	4750
RFB	Beam 40x120		2	4750
RB	17x114		86	1452

Floor Schedule

Mark	Type	Profile	Count	Length
FB	FB 17x114		36	2264

BB1	BB 20x40		2	4100
BB2	BB 20x40		4	2300

Fascia Schedule

Mark	Type	Profile	Count	Length
EE	Eave Edging 18x40		4	1496
RF	Roof Fascia 18x120		4	1496
RR1	Roof reinforce ment 18x95		2	4750
RR2	Roof reinforce ment 38x38		2	4750

Karina 40 (415x235)

List of all items 2

Wall 1			
Mark	Profile	Count	Cut Length

1BL-1	40x57	1	348
1BL-2	40x57	1	803
1BL-3	40x57	1	910
1LG-1	40x114	16	348
1LG-2	40x114	16	803
1LG-3	40x114	16	910
1LG-4	40x114	1	4350
1TL-1	40x114	1	4750

Wall A			
Mark	Profile	Count	Cut Length

ALG-1*	40x114	1	650
ALG-2*	40x114	1	1247
ALG-3*	40x114	1	1946
ALG-4*	40x114	1	2532
ALG-5	40x114	9	2550
ALG-6	40x114	18	890

Wall C			
Mark	Profile	Count	Cut Length

CLG-1*	40x114	1	650
CLG-2*	40x114	1	1247
CLG-3*	40x114	1	1946
CLG-4*	40x114	1	2532
CLG-5	40x114	9	2550
CLG-6	40x114	18	890

Wall 2			
Mark	Profile	Count	Cut Length



2BL-1	40x57	1	4350
2LG-1	40x114	17	4350
2TL-1	40x114	1	4750

Wall B			
Mark	Profile	Count	Cut Length

BLG-1*	40x114	1	650
BLG-2*	40x114	1	1247
BLG-3*	40x114	1	1946
BLG-4*	40x114	1	2532
BLG-5	40x114	18	2550

* Gable delivered premounted

Log profiles	
Profile	Profile

40x57	
40x114	

Log profiles	
Profile	Profile

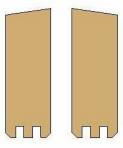
40x114	
--------	---